

阅读申明

- 1.本站收集的数据手册和产品资料都来自互联网，版权归原作者所有。如读者和版权方有任何异议请及时告之，我们将妥善解决。
- 2.本站提供的中文数据手册是英文数据手册的中文翻译，其目的是协助用户阅读，该译文无法自动跟随原稿更新，同时也可能存在翻译上的不当。建议读者以英文原稿为参考以便获得更精准的信息。
- 3.本站提供的产品资料，来自厂商的技术支持或者使用者的心得体会等，其内容可能存在描述上的差异，建议读者做出适当判断。
- 4.如需与我们联系，请发邮件到marketing@iczoom.com，主题请标有“数据手册”字样。

Read Statement

1. The datasheets and other product information on the site are all from network reference or other public materials, and the copyright belongs to the original author and original published source. If readers and copyright owners have any objections, please contact us and we will deal with it in a timely manner.
2. The Chinese datasheets provided on the website is a Chinese translation of the English datasheets. Its purpose is for reader's learning exchange only and do not involve commercial purposes. The translation cannot be automatically updated with the original manuscript, and there may also be improper translations. Readers are advised to use the English manuscript as a reference for more accurate information.
3. All product information provided on the website refer to solutions from manufacturers' technical support or users the contents may have differences in description, and readers are advised to take the original article as the standard.
4. If you have any questions, please contact us at marketing@iczoom.com and mark the subject with "Datasheets" .

V600 RFID System

Intelligent Flag III

V600-HAM42-DRT Intelligent Flag Amplifier

for CompoBus/D



Multi-functional amplifier conforming to OMRON's Network CompoBus/D compatible with *DeviceNet*

System Configuration

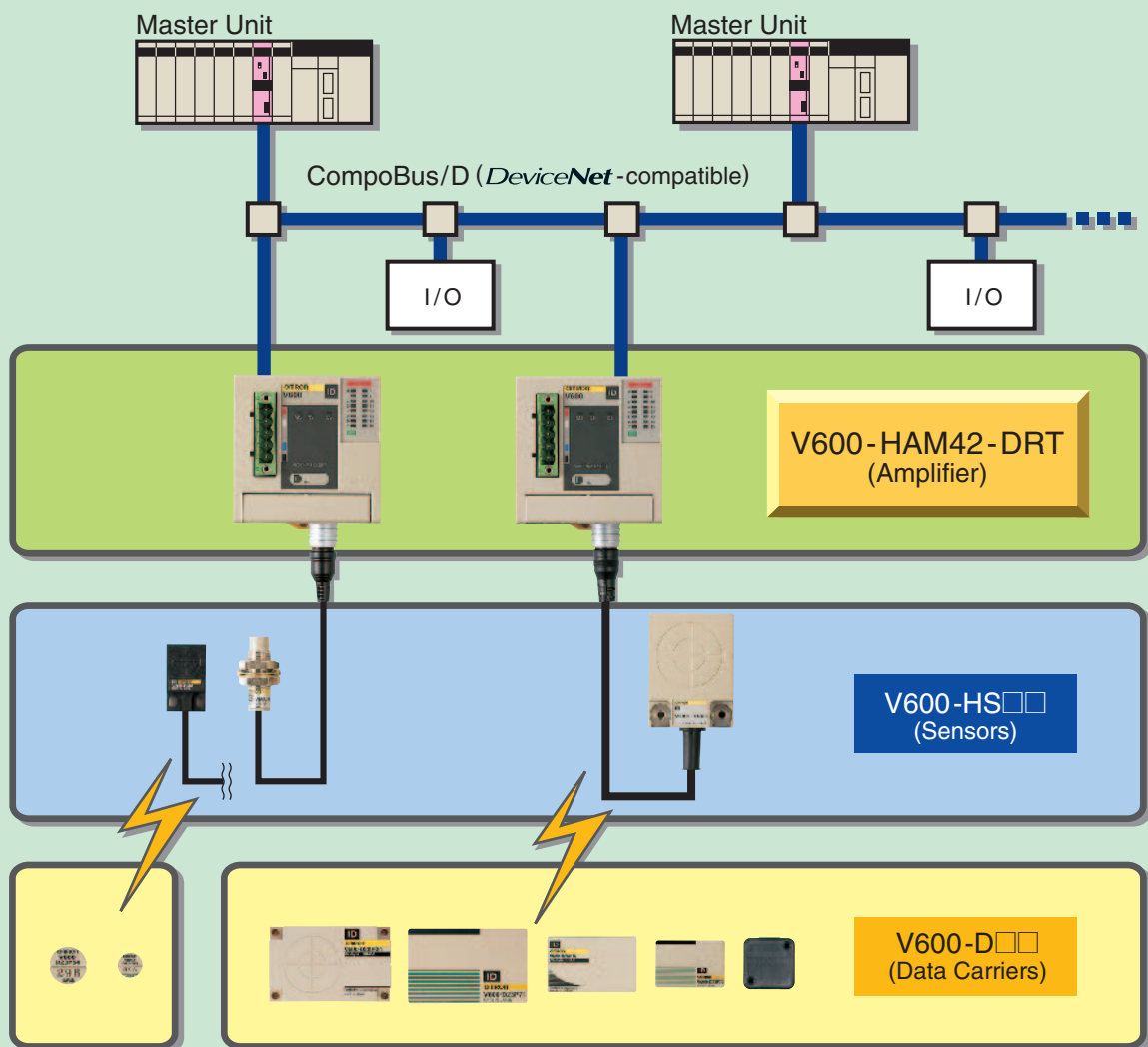

Intelligent Flag III V600-HAM42-DRT

An RFID system that is as easy and simple to use as a sensor. No programming required.

- Conforms to DeviceNet standards.
- Uses the same main functions (Read, Write, Bit Set, Bit Clear, etc.) as those of the V600-HA Intelligent Flag Series.
- Responds flexibly to applications with data reading up to 24 bits.
- Allows data to be written in units of up to 16 bits.
- CE marking/FCC approvals.







CE

Ordering Information/Specifications

■ Amplifier

Item	V600-HAM42-DRT
Communications power supply voltage	11 to 25 VDC (provided from communications connector)
Internal circuit power supply voltage	18 to 26.4 VDC
Internal current consumption	Communications power supply: 40 mA max. Internal circuit power supply: 150 mA max.
Noise immunity	Internal circuit power supply normal: ± 600 V Internal circuit power supply common: $\pm 1,500$ V
Dielectric strength	50/60 Hz at 500 V AC for 1 minute; leakage current 10 mA max.
Vibration resistance	10 to 55 Hz, 1.5-mm double amplitude, with 4 sweeps of 8 min each in 3 directions
Shock resistance	294 m/s ² , 3 times each in 3 directions (18 times total)
Ambient temperature	0 to 55°C (with no icing)
Ambient humidity	35% to 85% RH (with no condensation)
Storage temperature	-25 to 65°C
Degree of protection	IEC 60529: IP20 (panel mounted)
Mounting method	DIN track or direct mounting using accessory fittings (M4 screws)
Weight	Approx. 150 g

■ Sensor

Model	V600-HS51	V600-HS61	V600-HS63	V600-HS67
Shape				
Item				
Oscillation frequency	530 kHz			
Ambient temperature	-10 to 60°C		-10 to 70°C	
Storage temperature	-25 to 75°C			
Ambient humidity	35% to 95%			
Insulation resistance	50 MΩ (at 500 V DC) between cable terminal and case			
Dielectric strength	1,000 V AC, 50/50 Hz for 1 min between cable terminal and cable (leakage current 1 mA max.)			
Degree of protection	IEC 60529: IP67			
Vibration resistance	10 to 2,000 Hz, 3-mm double amplitude, with 2 sweeps of 15 min each in 3 directions		10 to 500 Hz, 2-mm double amplitude, with 3 sweeps of 11 min each in 3 directions	
Shock resistance	981 m/s ² , 3 times each in 3 directions (18 times total)		490 m/s ² , 3 times each in 3 directions (18 times total)	
Cable length	2 m (fixed)			
Wireless transmission error direction	16-bit CRC (Cyclic Redundancy Check) in both directions			
Indicator	---		Power: green	
Weight	Approx. 70 g		Approx. 190 g	Approx. 540 g

■ Performance

Number of Master words	Input: 2; output: 2 (total: 4 words)	
Number of sensor connections	1 channel	
Applicable sensors	V600-HS51, V600-HS61, V600-HS63, V600-HS67	
Read	DATA READ mode	Read 24 bits of data from the set address
Write	BYTE mode	Write 8-bit or 16-bit data from the set address
	BIT SET mode	Set (write "1") only the data for the bits that are set (with "1") at the set address
	BIT CLEAR mode	Clear (write "0") only the data for the bits that are set (with "1") at the set address

System Configuration

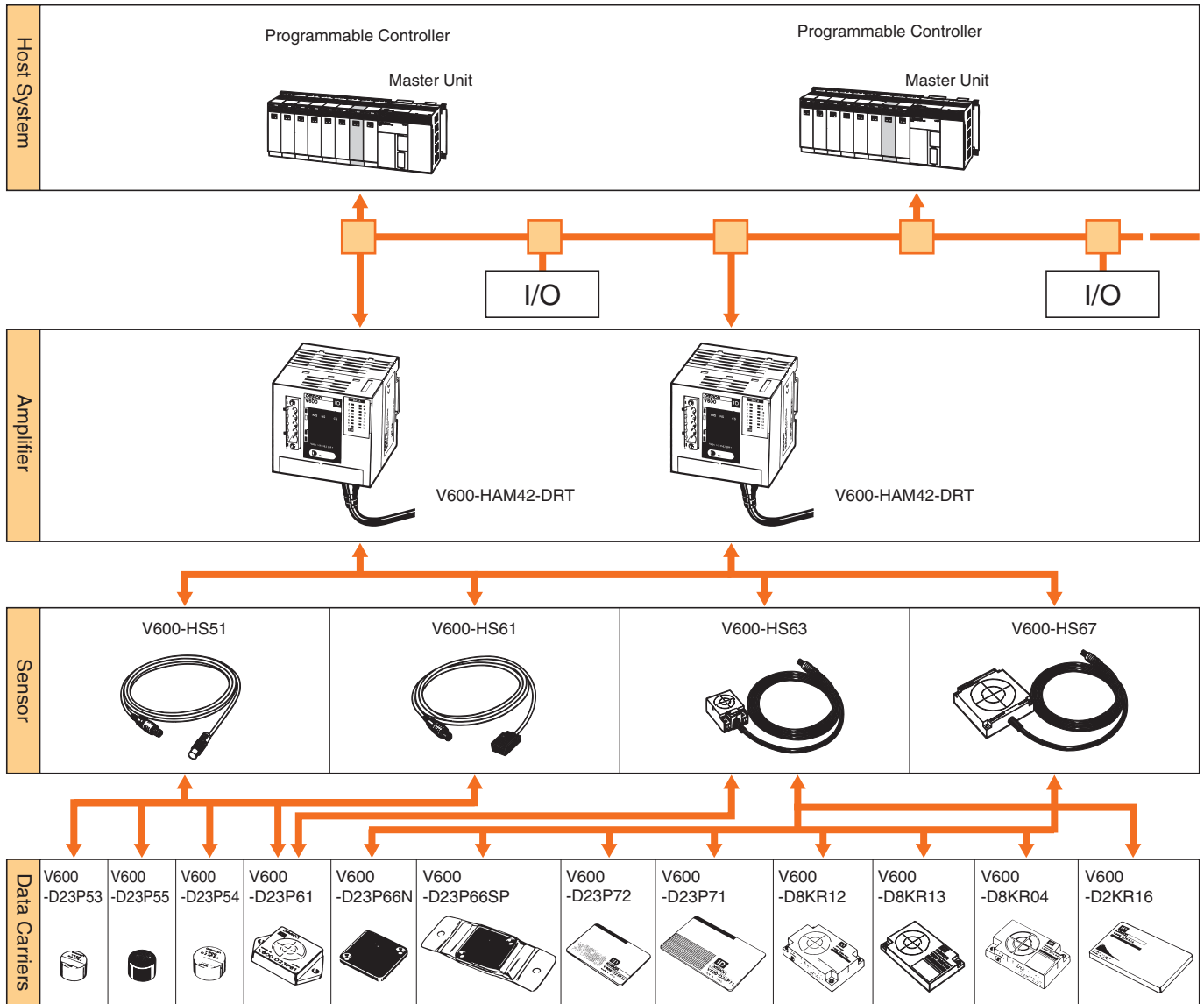

Transmission Distance Specifications

Data Carrier		Amplifier Sensor	V600-HAM42-DRT			
			V600-HS51	V600-HS61	V600-HS63	V600-HS67
Memory EEP-ROM Type	V600-D23P53		0.5 to 3.0 mm	0.5 to 3.0 mm	---	---
	V600-D23P54		0.5 to 5.0 mm	0.5 to 5.5 mm	---	---
	V600-D23P55		0.5 to 7.0 mm	0.5 to 7.0 mm	---	---
	V600-D23P61		0.5 to 8.0 mm	0.5 to 9.0 mm	2 to 16 mm	---
	V600-D23P66N		---	---	5 to 30 mm	5 to 35 mm
	V600-D23P66SP		---	---	5 to 25 mm	5 to 30 mm
	V600-D23P71		---	---	5 to 35 mm	10 to 65 mm
	V600-D23P72		---	0.5 to 18 mm	5 to 35 mm	10 to 45 mm
Memory S-RAM Type	V600-D8KR12		5 to 15 mm	5 to 18 mm	5 to 45 mm	10 to 50 mm
	V600-D8KR13		---	---	2 to 15 mm	---
	V600-D2KR16		---	---	2 to 15 mm	---
	V600-D8KR04		---	---	10 to 65 mm	10 to 90 mm

Note: 1. Sensor installation conditions

- V600-HS51: When flush-mounted in iron
Axial offset from the Data Carrier ± 2.0 mm
- V600-HS61: When surface-mounted on metal (ferrous)
Axial offset from the Data Carrier: ± 2.0 mm
- V600-HS63: When surface-mounted on metal (ferrous)
Axial offset from the Data Carrier: ± 10.0 mm
- V600-HS67: When surface-mounted on metal (ferrous)
Axial offset from the Data Carrier: ± 10.0 mm

2. Data Carrier installation conditions

- V600-D23P53/-P54: When flush-mounted in iron
- V600-D23P55: When flush-mounted in iron, the transmission distance decreases greatly.
- V600-D23P66N/-P66SP/-P71/-P72: When surface-mounted on resin (no metal on the backside)
- V600-D23P61: When surface-mounted on metal (ferrous)
- V600-D8KR12/13/04: When surface-mounted on metal (ferrous)
- V600-D2KR16: When the Data Carrier attached to the holder is mounted on metal (ferrous)

- 3. The transmission distance specified in the specifications is also applicable when the Data Carrier is mounted on non-metallic surfaces.
- 4. The Data Carrier is stationary.

Characteristic Data (Typical)

Transmission Range

Note: All units are in millimeters unless otherwise indicated.

Combinations with the V600-HS51 Sensor

V600-HS51 & V600-D23P53

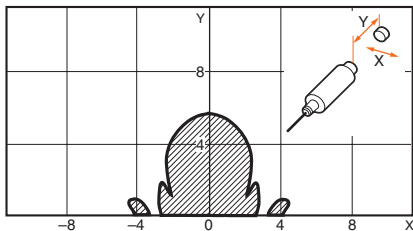

V600-HS51 & V600-D23P54

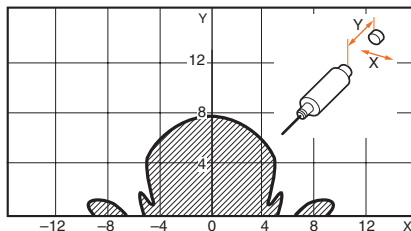

V600-HS51 & V600-D23P55

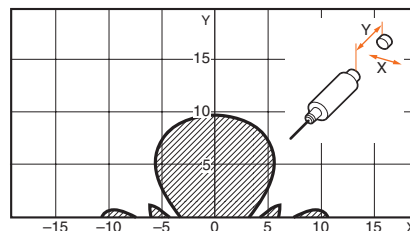

V600-HS51 & V600-D23P61

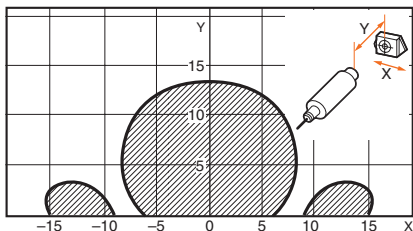

V600-HS51 & V600-D8KR12

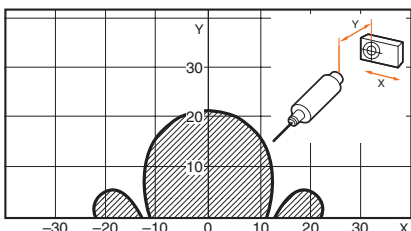

Combinations with the V600-HS61 Sensor

V600-HS61 & V600-D23P53

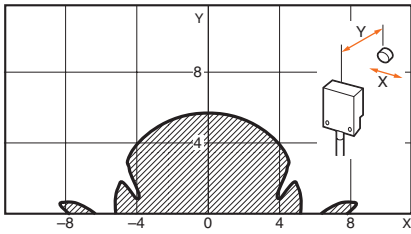

V600-HS61 & V600-D23P54

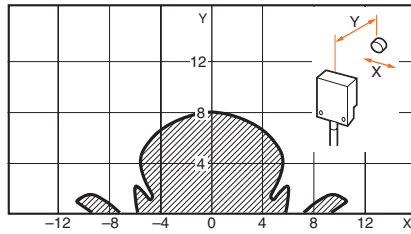

V600-HS61 & V600-D23P55

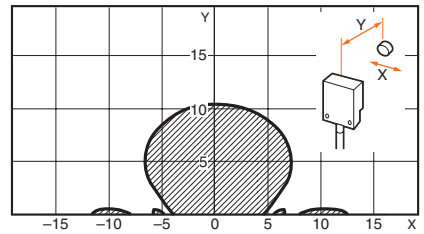

V600-HS61 & V600-D23P61

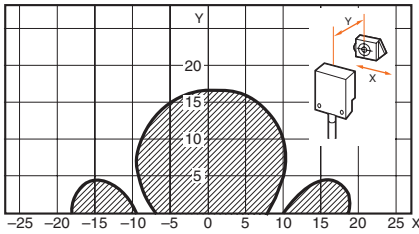

V600-HS61 & V600-D23P72

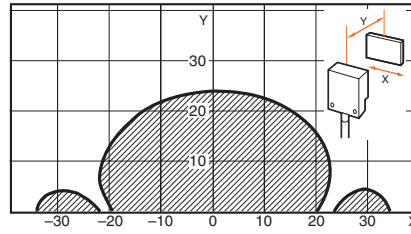

V600-HS61 & V600-D8KR12

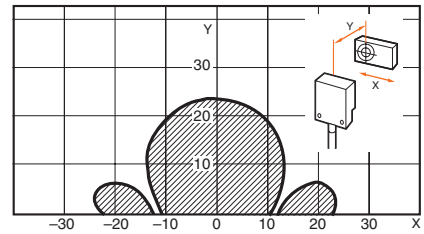

Combinations with the V600-HS63 Sensor

V600-HS63 & V600-D23P55

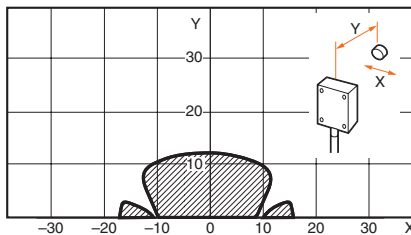

V600-HS63 & V600-D23P61

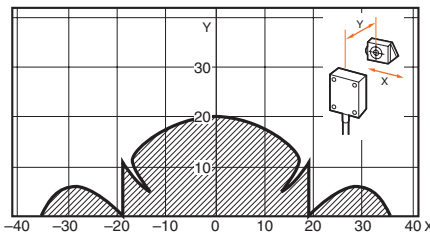

V600-HS63 & V600-D23P66N

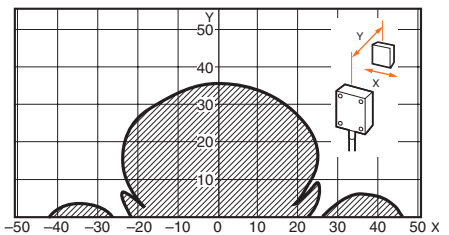

V600-HS63 & V600-D23P66SP

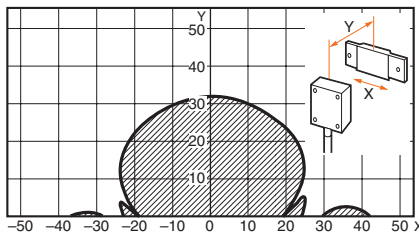

V600-HS63 & V600-D23P71

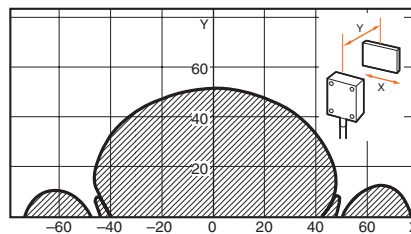

V600-HS63 & V600-D23P72

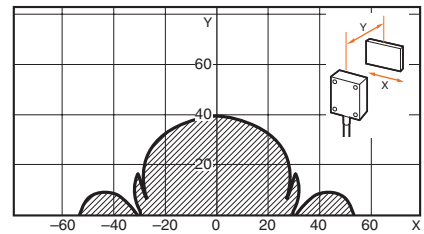

V600-HS63 & V600-D8KR12

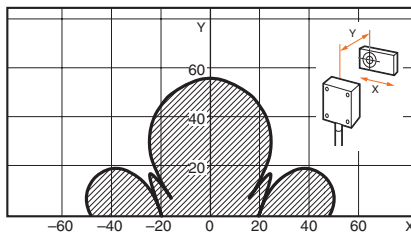

V600-HS63 & V600-D8KR13

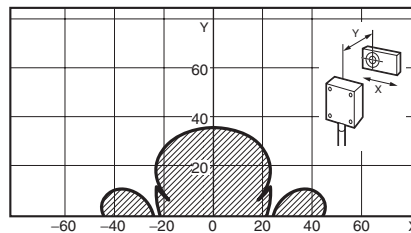

V600-HS63 & V600-D8KR04

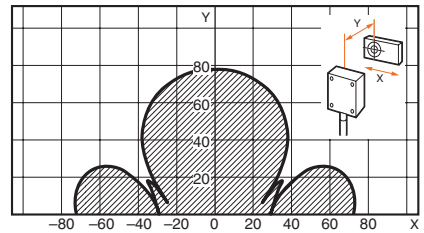

V600-HS63 & V600-D2KR16

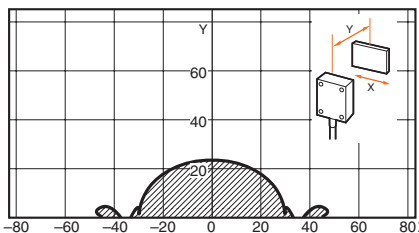

Combinations with the V600-HS67 Sensor

V600-HS67 & V600-D23P66N

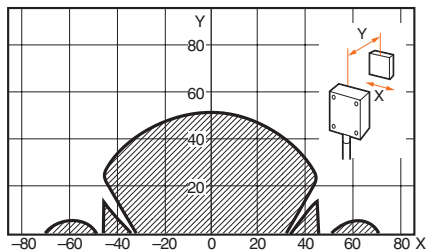

V600-HS67 & V600-D23P66SP

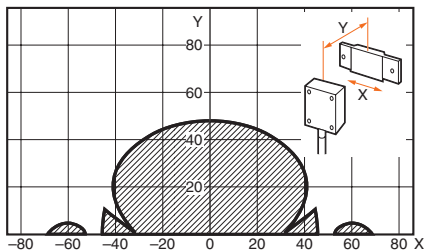

V600-HS67 & V600-D23P71

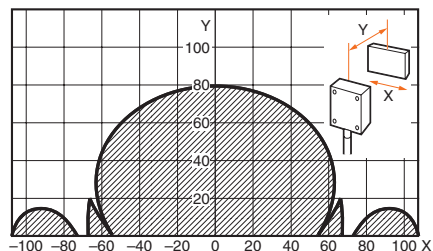

V600-HS67 & V600-D23P72

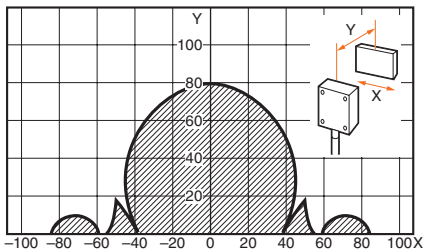

V600-HS67 & V600-D8KR12

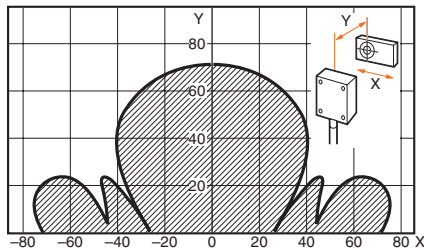

V600-HS67 & V600-D8KR13

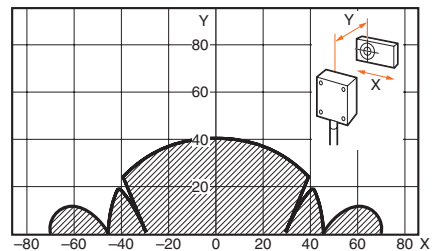

V600-HS67 & V600-D8KR04

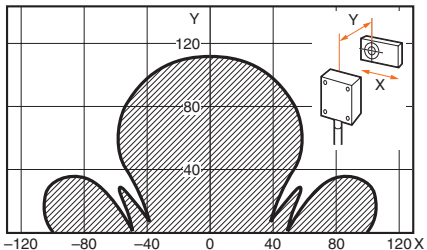

Transmission Time

The transmission time is the time required for transmission between the Sensor and the Data Carrier.

Model		V600-HAM42-DRT		
		Read		Write
Mode type		DATA READ mode	BYTE mode	BIT SET mode, BIT CLEAR mode
Data Carrier type	Battery-less type	79 ms	140 ms	152 ms
	Built-in battery type	64 ms	97 ms	109 ms

Battery-less type: V600-D23P53, V600-D23P54, V600-D23P55, V600-D23P61, V600-D23P66N, V600-D23P66SP, V600-D23P72, V600-D23P71, V600-D23P72

Built-in battery type: V600-D8KR12, V600-D8KR13, V600-D8KR04, V600-D2KR16

Dimensions

Note: All units are in millimeters unless otherwise indicated.

Amplifier

V600-HAM42-DRT

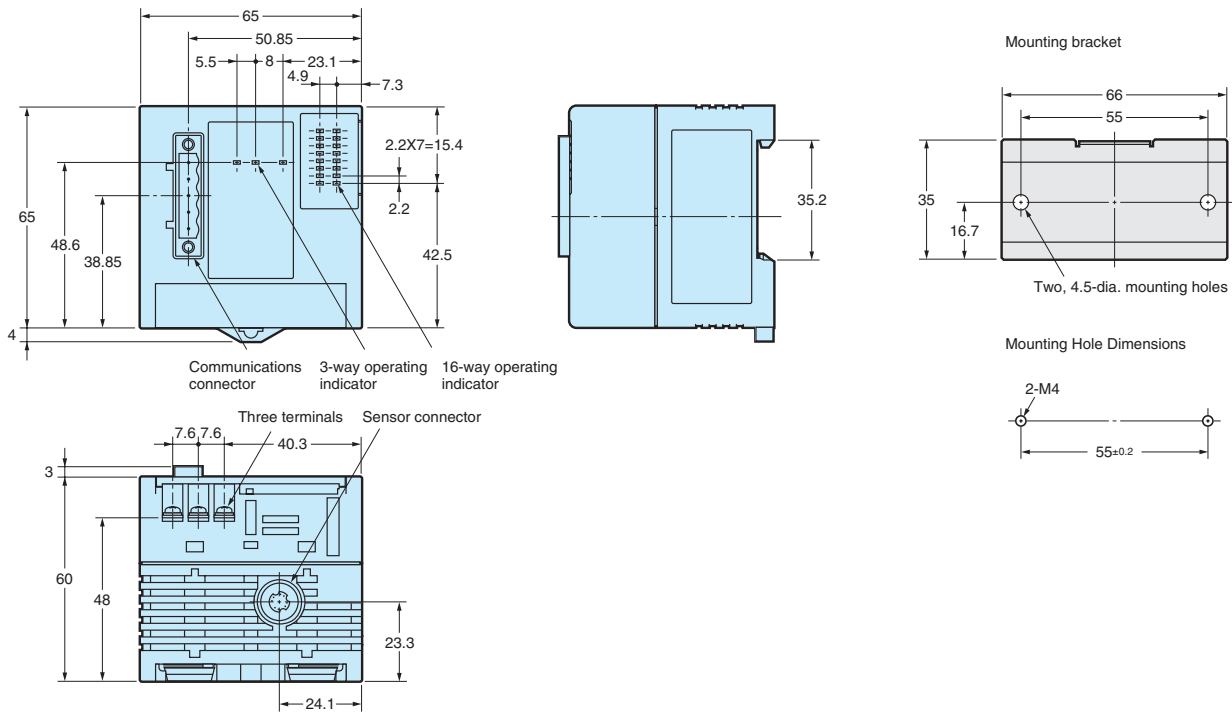

Sensor

V600-HS51

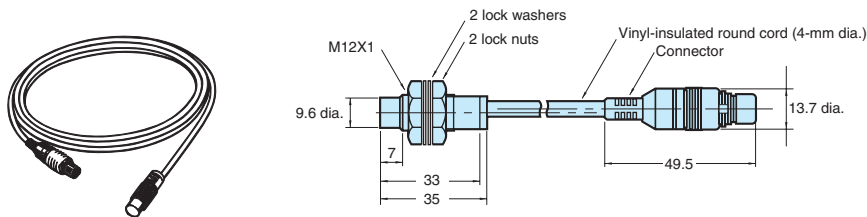

V600-HS61

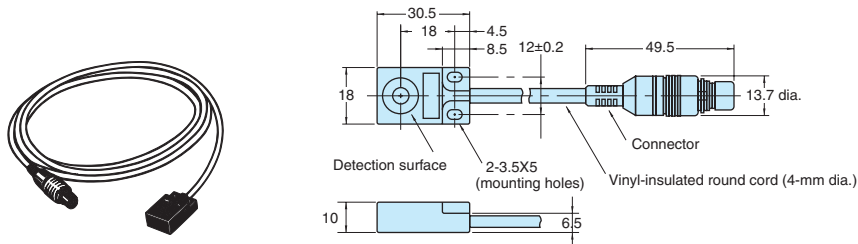

V600-HS63

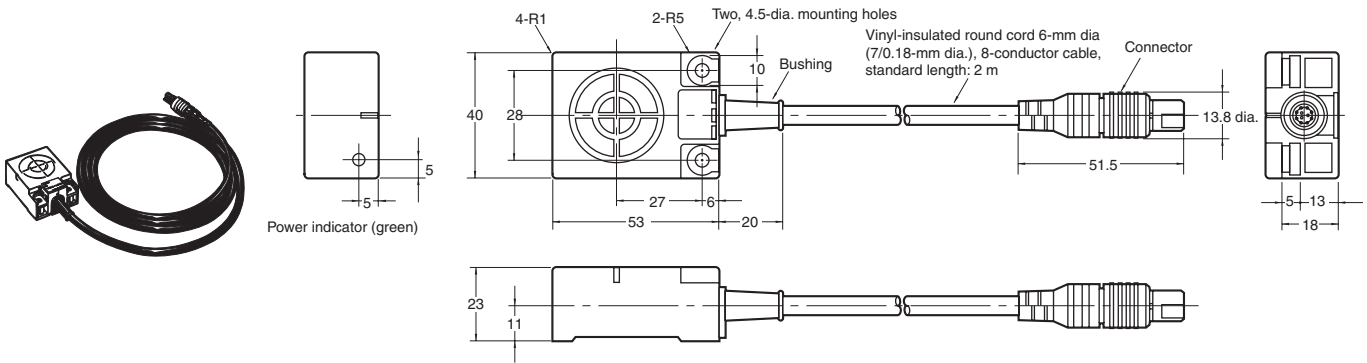

V600-HS67

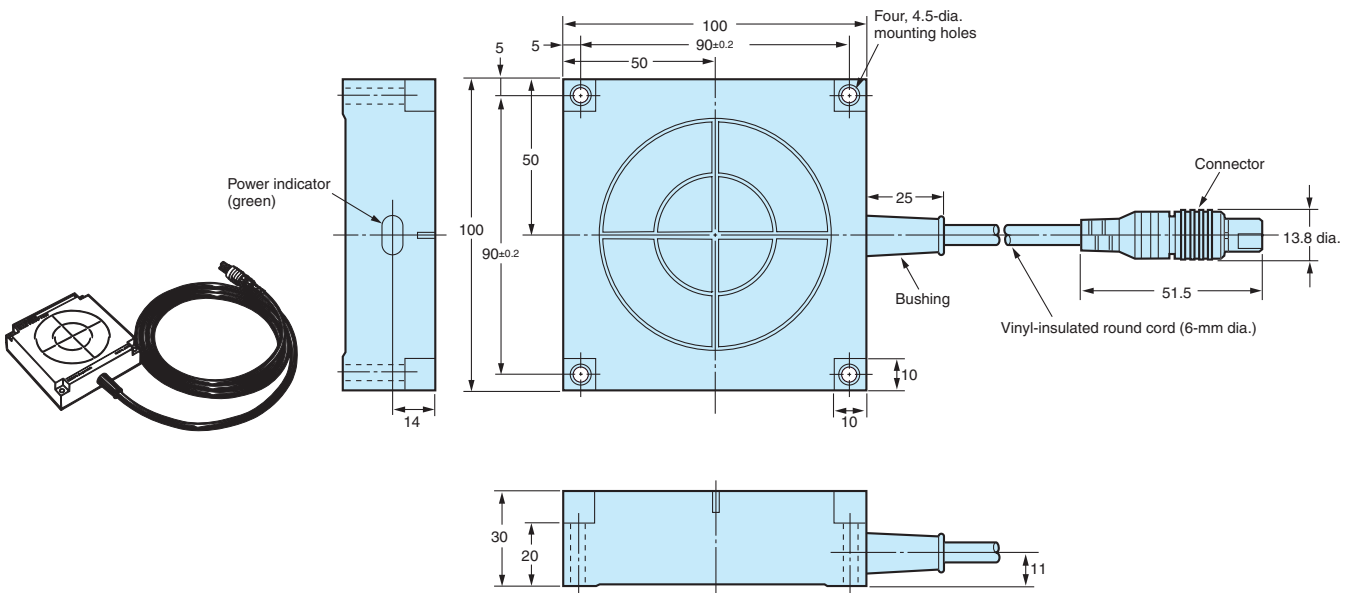

V600-series Data Carrier

Built-in-battery DCs

V600-D8KR12

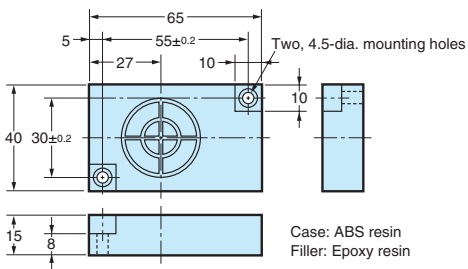

V600-D8KR04

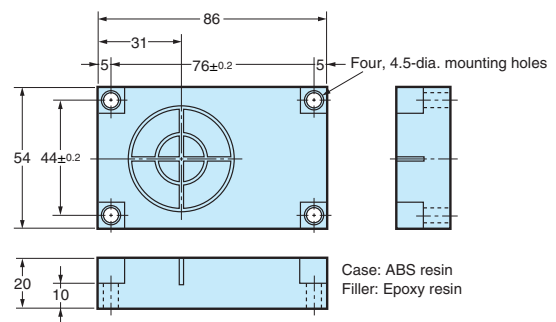

V600-D8KR13

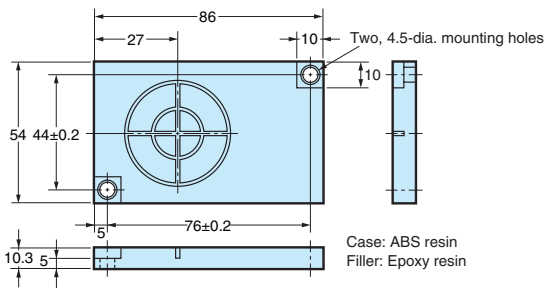

Replaceable-battery DCs

V600-D2KR16

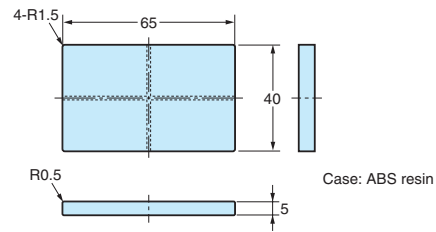

Battery-less DCs

V600-D23P53

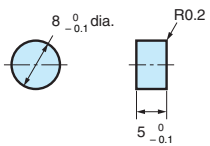

Case: ABS resin
Filler: Epoxy resin

V600-D23P54

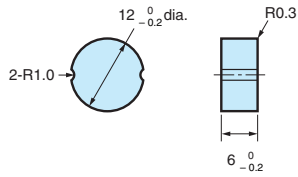

Case: ABS resin
Filler: Epoxy resin

V600-D23P55

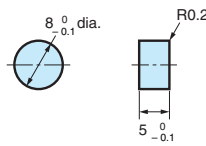

Case: PPS resin
Filler: Epoxy resin

V600-D23P61

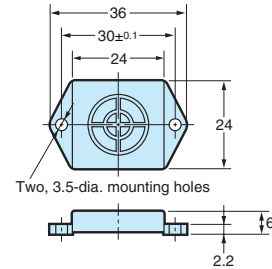

Case: ABS resin
Filler: Epoxy resin

V600-D23P66N

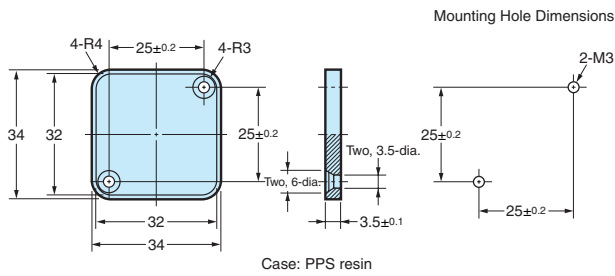

V600-D23P72

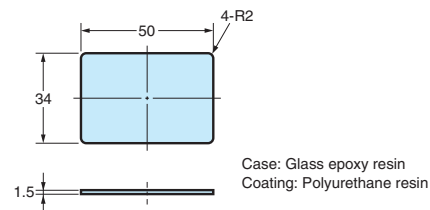

V600-D23P66SP

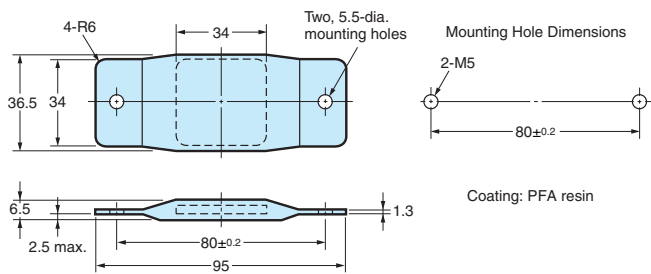

V600-D23P71

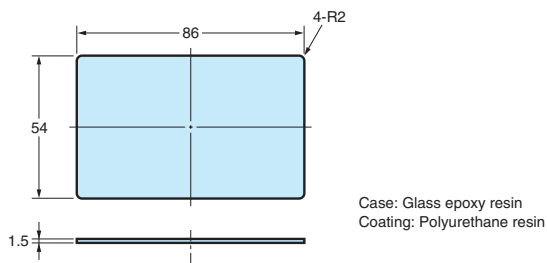

ALL DIMENSIONS SHOWN ARE IN MILLIMETERS.
To convert millimeters into inches, multiply by 0.03937. To convert grams into ounces, multiply by 0.03527.

READ AND UNDERSTAND THIS DOCUMENT

Please read and understand this document before using the products. Please consult your OMRON representative if you have any questions or comments.

WARRANTY

OMRON's exclusive warranty is that the products are free from defects in materials and workmanship for a period of one year (or other period if specified) from date of sale by OMRON.

OMRON MAKES NO WARRANTY OR REPRESENTATION, EXPRESS OR IMPLIED, REGARDING NON-INFRINGEMENT, MERCHANTABILITY, OR FITNESS FOR PARTICULAR PURPOSE OF THE PRODUCTS. ANY BUYER OR USER ACKNOWLEDGES THAT THE BUYER OR USER ALONE HAS DETERMINED THAT THE PRODUCTS WILL SUITABLY MEET THE REQUIREMENTS OF THEIR INTENDED USE. OMRON DISCLAIMS ALL OTHER WARRANTIES, EXPRESS OR IMPLIED.

LIMITATIONS OF LIABILITY

OMRON SHALL NOT BE RESPONSIBLE FOR SPECIAL, INDIRECT, OR CONSEQUENTIAL DAMAGES, LOSS OF PROFITS OR COMMERCIAL LOSS IN ANY WAY CONNECTED WITH THE PRODUCTS, WHETHER SUCH CLAIM IS BASED ON CONTRACT, WARRANTY, NEGLIGENCE, OR STRICT LIABILITY.

In no event shall responsibility of OMRON for any act exceed the individual price of the product on which liability is asserted.

IN NO EVENT SHALL OMRON BE RESPONSIBLE FOR WARRANTY, REPAIR, OR OTHER CLAIMS REGARDING THE PRODUCTS UNLESS OMRON'S ANALYSIS CONFIRMS THAT THE PRODUCTS WERE PROPERLY HANDLED, STORED, INSTALLED, AND MAINTAINED AND NOT SUBJECT TO CONTAMINATION, ABUSE, MISUSE, OR INAPPROPRIATE MODIFICATION OR REPAIR.

SUITABILITY FOR USE

THE PRODUCTS CONTAINED IN THIS DOCUMENT ARE NOT SAFETY RATED. THEY ARE NOT DESIGNED OR RATED FOR ENSURING SAFETY OF PERSONS, AND SHOULD NOT BE RELIED UPON AS A SAFETY COMPONENT OR PROTECTIVE DEVICE FOR SUCH PURPOSES. Please refer to separate catalogs for OMRON's safety rated products.

OMRON shall not be responsible for conformity with any standards, codes, or regulations that apply to the combination of products in the customer's application or use of the product.

At the customer's request, OMRON will provide applicable third party certification documents identifying ratings and limitations of use that apply to the products. This information by itself is not sufficient for a complete determination of the suitability of the products in combination with the end product, machine, system, or other application or use.

The following are some examples of applications for which particular attention must be given. This is not intended to be an exhaustive list of all possible uses of the products, nor is it intended to imply that the uses listed may be suitable for the products:

- Outdoor use, uses involving potential chemical contamination or electrical interference, or conditions or uses not described in this document.
- Nuclear energy control systems, combustion systems, railroad systems, aviation systems, medical equipment, amusement machines, vehicles, safety equipment, and installations subject to separate industry or government regulations.
- Systems, machines, and equipment that could present a risk to life or property.

Please know and observe all prohibitions of use applicable to the products.

NEVER USE THE PRODUCTS FOR AN APPLICATION INVOLVING SERIOUS RISK TO LIFE OR PROPERTY WITHOUT ENSURING THAT THE SYSTEM AS A WHOLE HAS BEEN DESIGNED TO ADDRESS THE RISKS, AND THAT THE OMRON PRODUCT IS PROPERLY RATED AND INSTALLED FOR THE INTENDED USE WITHIN THE OVERALL EQUIPMENT OR SYSTEM.

PERFORMANCE DATA

Performance data given in this document is provided as a guide for the user in determining suitability and does not constitute a warranty. It may represent the result of OMRON's test conditions, and the users must correlate it to actual application requirements. Actual performance is subject to the OMRON Warranty and Limitations of Liability.

CHANGE IN SPECIFICATIONS

Product specifications and accessories may be changed at any time based on improvements and other reasons.

It is our practice to change model numbers when published ratings or features are changed, or when significant construction changes are made. However, some specifications of the product may be changed without any notice. When in doubt, special model numbers may be assigned to fix or establish key specifications for your application on your request. Please consult with your OMRON representative at any time to confirm actual specifications of purchased products.

DIMENSIONS AND WEIGHTS

Dimensions and weights are nominal and are not to be used for manufacturing purposes, even when tolerances are shown.

ERRORS AND OMISSIONS

The information in this document has been carefully checked and is believed to be accurate; however, no responsibility is assumed for clerical, typographical, or proofreading errors, or omissions.

PROGRAMMABLE PRODUCTS

OMRON shall not be responsible for the user's programming of a programmable product, or any consequence thereof.

COPYRIGHT AND COPY PERMISSION

This document shall not be copied for sales or promotions without permission.

This document is protected by copyright and is intended solely for use in conjunction with the product. Please notify us before copying or reproducing this document in any manner, for any other purpose. If copying or transmitting this document to another, please copy or transmit it in its entirety.

Cat. No. Q115-E1-02

In the interest of product improvement, specifications are subject to change without notice.

OMRON Corporation

Industrial Automation Company

**Application Sensors Division
Sensing Devices and Components Division H.Q.**

Shiokoji Horikawa, Shimogyo-ku,
Kyoto, 600-8530 Japan

Tel: (81)75-344-7068/Fax: (81)75-344-7107

Printed in Japan
1004 (0203)

